

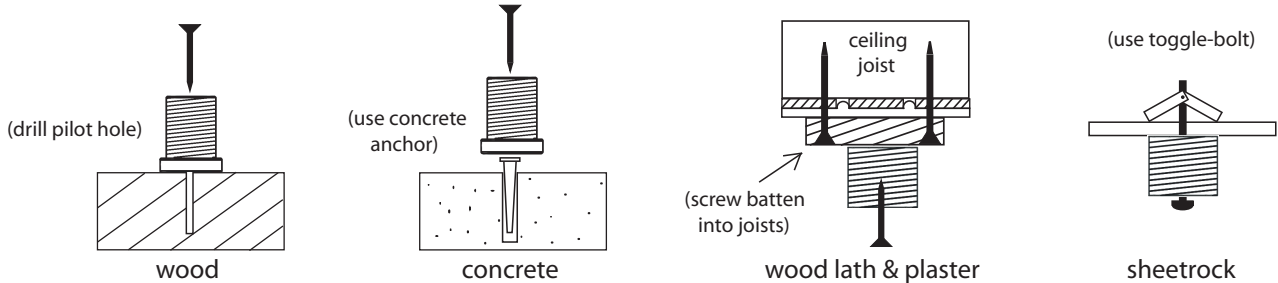





Floor-to-Ceiling Cable System Assembly Instructions

1 A. Read all instructions before proceeding with installation. Make sure you fully understand the steps necessary for installing a cable system.

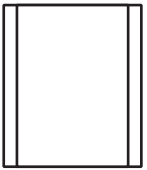
B. The most important part of the cable system is how it is mounted. The cable mounts have to support the weight of the assembly as well as hold the cable in tension. See examples below of different ceiling and floor types and their required mechanical fasteners. ***This responsibility is that of the installer.***

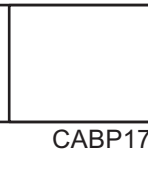

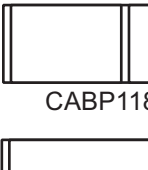
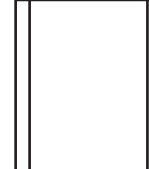
2 A. For distances between the cables, refer to which acrylic accessories you plan to use. Match your accessories with the ones shown in the following table:

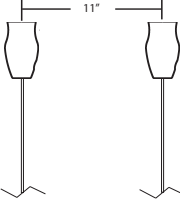
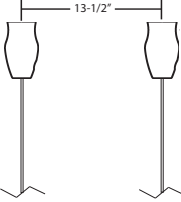
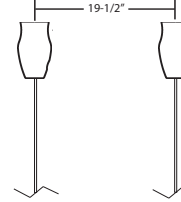
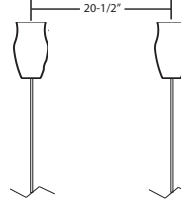
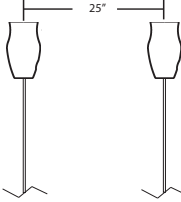
DISTANCE BETWEEN CABLE CENTERS				
 CABP8511	 CABP1185	 CABP1711	 CABP8511X2	 CABP1185X2
 CABP1117	 CABP1824	 CABP2228		
 11"	 13-1/2"	 19-1/2"	 20-1/2"	 25"
11"	13-1/2"	19-1/2"	20-1/2"	25"

3 A. Transfer your center marks from the ceiling to the floor, using string and a plumb bob. After drilling hole locations into your floor and ceiling following the diagrams above, unpack the cable mounts and unscrew the mounts from the toppers. Keep insert and spring with floor topper. Screw the mounts to the floor and ceiling using the applicable fastener for your wall type.

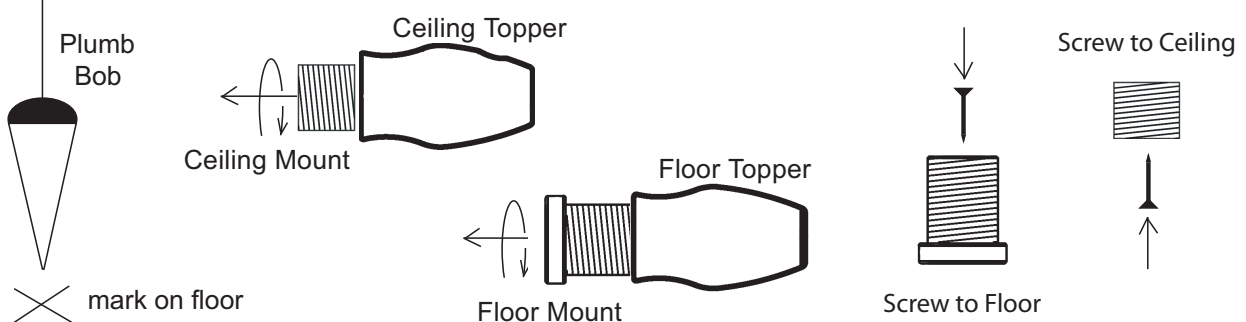

Floor-to-Ceiling Cable System Assembly Instructions

4

A. See below the schematic layout for the cable system assembly. Insert one end of the cable into the ceiling topper. Stop when cable begins to exit small hole. Using the included hex key, secure cable with set screw as shown in fig.1. Thread the collar onto the cable and screw up onto the mount until tight.

B. For the lower cable mount, thread the topper first then the spring and lastly the cable insert onto the cable. Align the bottom of the cable insert to just below (1/8") the top threads of the cable mount as shown in fig. 2 and attach to cable with set screw. Cut the cable 1/4" beneath the insert.

C. Place the insert into the cable mount and screw the collar down (fig. 3) until the cable gets taut. Don't overtighten the cable. It can be adjusted after the acrylic accessories are mounted.

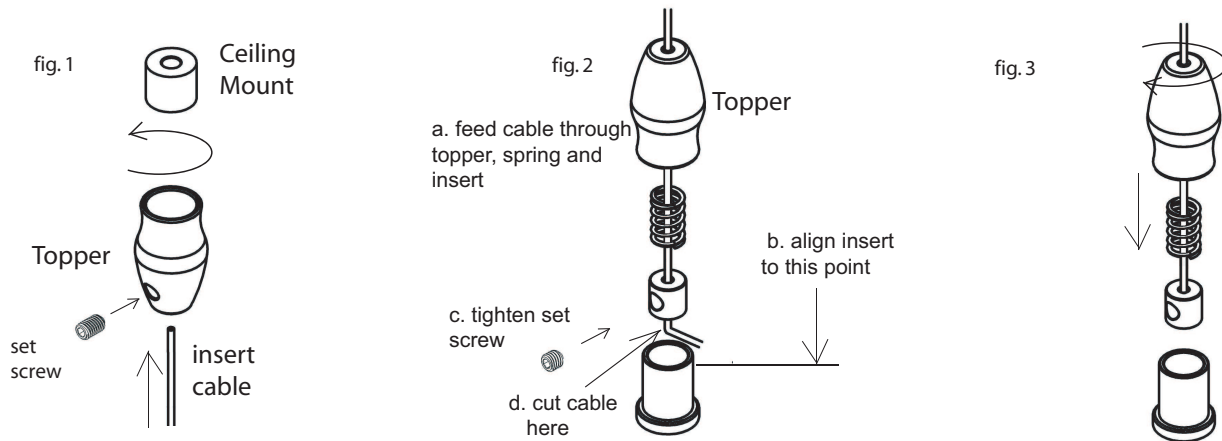

5

A. Unpack the cable clamps and align them approximately one inch from each corner of acrylic accessories (fig. 4). Attach using the hex key and the FLAT set screws. Use (1) set screw for each clamp (fig. 5).

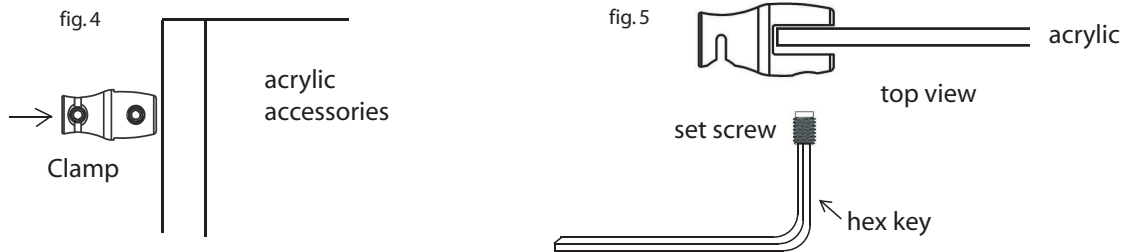

6

A. Place the acrylic accessories onto the cables and make sure they are level. Locations on the cables are entirely up to you. Secure the accessories to the cables using the included set screws, shown in fig. 6. Once all acrylic accessories are installed, you can tighten or loosen the cable tension at the bottom cable mount with a turn of the collar. Movement for this type of display is normal.

